

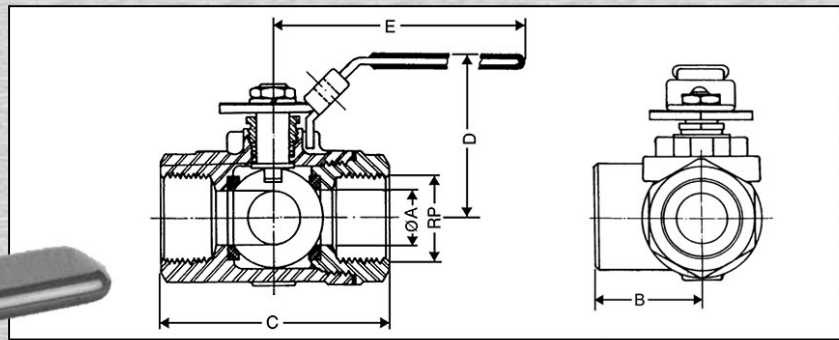













3-Wege-Kugelhahn aus Edelstahl

**Stainless steel
3-way ball valve**



**Auf Anfrage T-Bohrung
On request T-bore**

**L-Bohrung – Standard
L-bore**

Stellung 0							
Stellung 90							

Gewinde							Bestell-Nummer Order-No.	Preis Price €
Rp	DN	A	B	C	D	E		
1/4"	*)	*)	*)	*)	*)	*)	NKH3W-G 1.4	*)
3/8"	10	12,7	30	60	56	110	NKH3W-G 3.8	*)
1/2"	15	12,7	30	60	56	110	NKH3W-G 1.2	*)
3/4"	20	16	38	74	64	130	NKH3W-G 3.4	*)
1"	25	20	41	82	66	130	NKH3W-G 1.1	*)
1 1/4"	32	25	61	96	78	145	NKH3W-G 5.4	*)
1 1/2"	40	32	61	112	83	150	NKH3W-G 3.2	*)
2"	50	38,1	69	138	88	150	NKH3W-G 4.2	*)

Anschlüsse: Schneidring DIN 2353; **Connections:** Flare tube fittings, *) Bitte Preisliste anfordern!
Bördel, Schweißkegel, auf Anfrage. *welding nipple, on request.* *) **Please, request price list!**
Maßänderungen vorbehalten. *Measurements subject to alteration.*

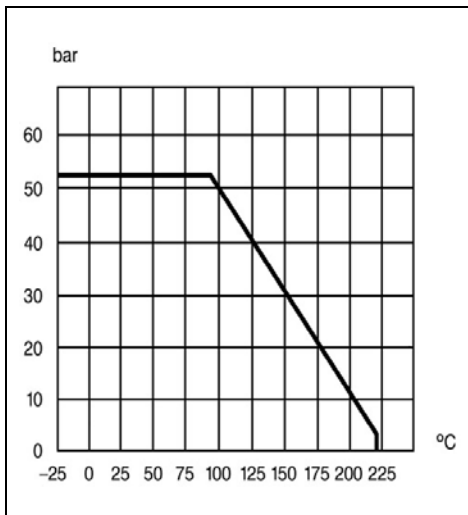

Type: NKH3W-G ...
Ausführung: Körper 2-teilig, voller Durchgang, allseitig gedichtet
Anschluß: Innengewinde von G 1/4" bis G 2"
Betätigung: Drehwinkel von 90°
Temperatur: von -30° C bis +180° C
Betriebsdruck: PN 50
Kugel: L-Bohrung

Werkstoffe:
Gehäuse: Edelstahl 1.4408
Kugel: Edelstahl 1.4408
Kugeldichtung: PTFE
Spindeldichtung: PTFE
Handhebel: Edelstahl mit Kunststoffüberzug

Type: NKH3W-G ...
Model: two piece ball valve, full bore
Size: from 1/4" to 2" inside thread
Operation: turning valve key through 90°
Temperature: from -30° C to +180° C
Working pressure: 50 bar
Ball: L-bore

Materials:
Body: AISI 316
Ball: AISI 316
Sealing: PTFE
Handle: AISI 304